

# Handle

To open and close door or window

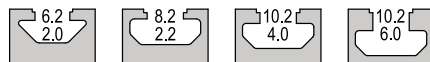
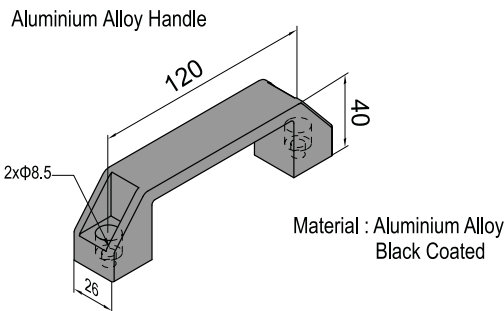
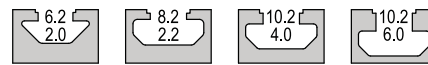
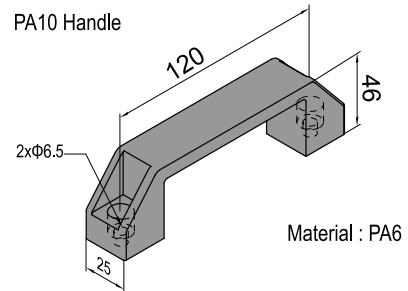
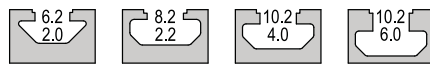
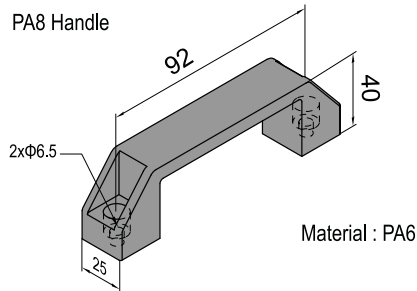
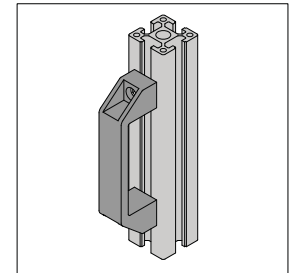

Description	Mass (g)	Part No.
PA8 Handle	38	08.HE.92.PA
PA10 Handle	60	10.HE.120.PA
Aluminium Alloy Handle	81	10.HE.120.AA